

## 950mm 2.4GHz RTR R/C High Performance Racing Sailboat



# dragonflite 95

### RIGGING INSTRUCTION MANUAL

Covers boats from 2019 onwards

For more information about the boat  
and the DragonFlite 95 racing class, visit:

[www.dfracing.world](http://www.dfracing.world)

### Specification

- Length: 950mm
- Beam: 125mm
- Rig height: 1050mm
- Overall height: 1470mm
- RTR total weight 2000g (Batteries not included)
- Sail area (Mainsail): 2314cm<sup>2</sup>
- Sail area (Jib): 1422cm<sup>2</sup>
- Sail area (Overall): 3736cm<sup>2</sup>
- Overall height: 1470mm
- Hull material: Moulded plastic with painted finish and logo sticker
- Requires: 4pcs AA battery for transmitter & 4pcs AA battery for receiver



# INSTRUCTION MANUAL

**THIS MODEL IS NOT A TOY  
THESE INSTRUCTIONS SHOULD BE READ BY A SUPERVISING ADULT**

## DRAGONFLITE 95 2.4GHz RTR RACING SAILBOAT

MODEL No: 8811

### IMPORTANT:

- This is not a toy. Assembly and operating of this boat requires adult supervision.
- Please take time to read these instructions carefully and completely before attempting to operate your model. This manual contains the instructions you need to safely build operate and maintain you R/C sailboat.

## BOX CONTENTS

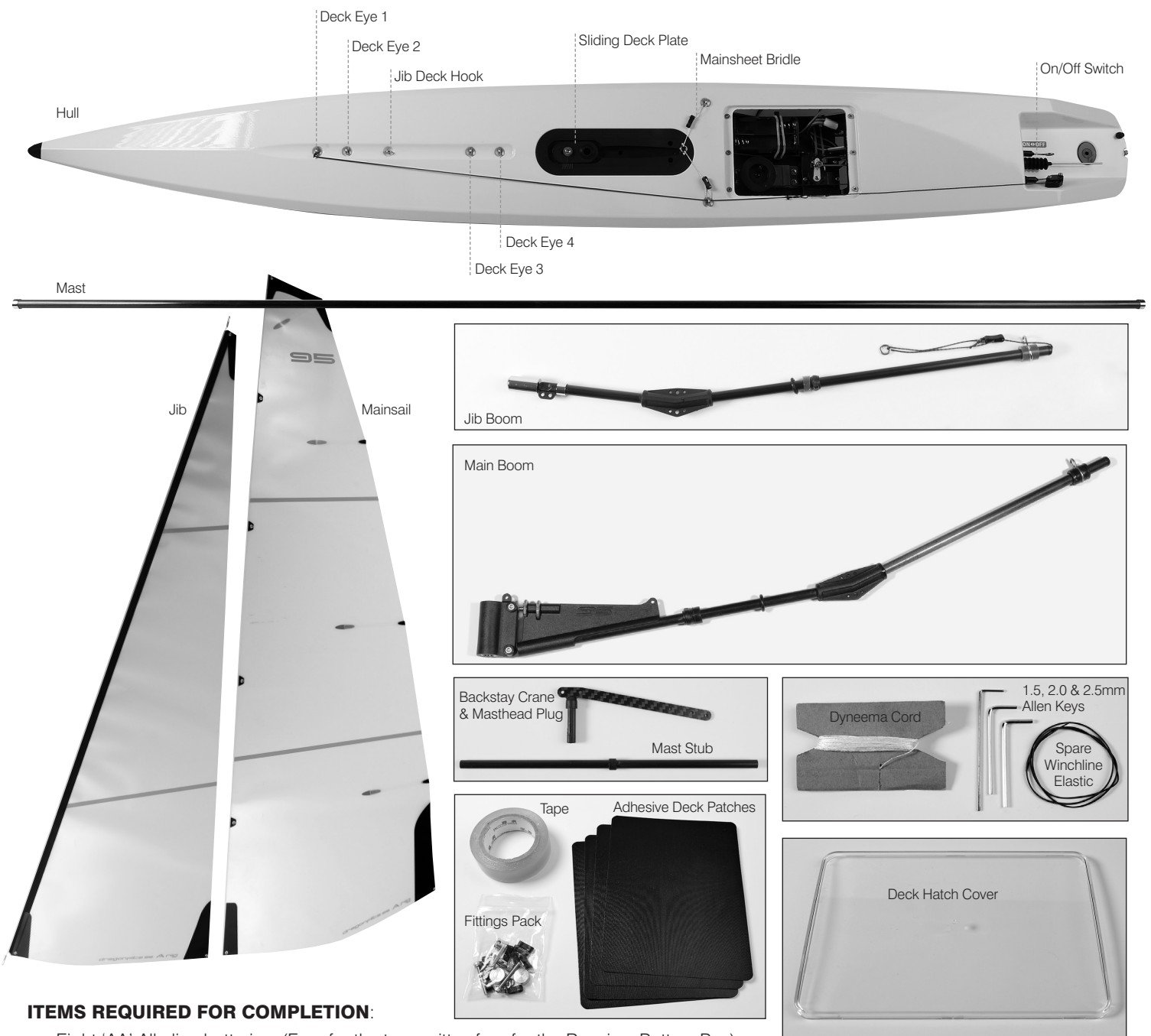

### ITEMS REQUIRED FOR COMPLETION:

- Eight 'AA' Alkaline batteries. (Four for the transmitter, four for the Receiver Battery Box).
- Thin CA glue (cyanoacrylate/superglue).
- A pair of thin nosed pliers and a sharp craft knife or scalpel.

## BASIC BOAT TERMINOLOGY

<b>BOW</b>	The front of the boat.
<b>STERN</b>	The back of the boat.
<b>PORT</b>	This is the left side of the boat when viewed from the Stern.
<b>STARBOARD</b>	This is the right side of the boat when viewed from the Stern.
<b>HULL</b>	The body of the boat.
<b>DECK</b>	The upper surface of the Hull.
<b>KEEL</b>	A weighted blade that protrudes from the bottom of the hull as a means of providing lateral stability.
<b>RUDDER</b>	The hinged vertical blade mounted at the Stern used as a steering device.



## DISPLAY STAND ASSEMBLY

- 1 Identify all stand components from box.
- 2 Bolt the plastic moulded components together with the twelve nut & bolts supplied.
- 3 Construct the leg sections. *Note: All leg and stretcher tubes are of equal length.*
- 4 Fit the three stretcher tubes.
- 5 Fix the soft EVA foam supports to the top surface of the stand to protect the Hull from scratches.

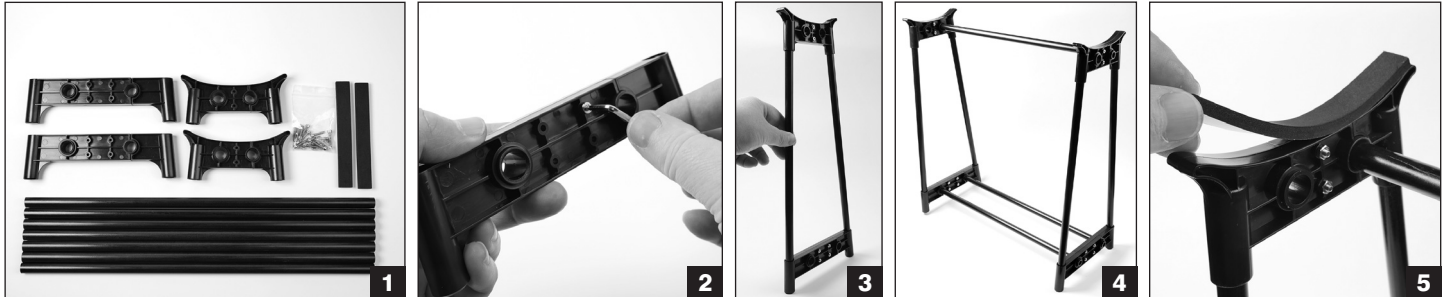

## KEEL & KEEL BULB ASSEMBLY

- 1 Identify all Keel & Bulb components from box.
- 2 Insert plastic 'Shoes' into bulb slot.
- 3 *Tip: To make it easier to align the bolt holes in the Fixing Disk, mark the centres of the threaded holes on the side of the Fixing Disk.*
- 4 Insert the Fixing Disk into the pre-drilled hole in the Keel taking care to align the threaded holes and screw in the hex-head bolt to ensure everything is aligned correctly. It's a good idea at this point to stick the disk in place with a piece of thin tape to prevent it moving whilst fitting into the Keel Bulb. Then remove bolt.
- 5 Slide the Keel into the Bulb, between the Plastic Shoes and secure with the hex-head bolt.
- 6 Repeat step four for the top fixing.
- 7 Slide the top of the Keel into the Hull and secure with the remaining hex-head bolt.



## RUDDER ASSEMBLY

- 1 Identify all Rudder components from box.
- 2 Insert Rudder into Hull.
- 3 Loosely fit the metal Rudder Arm on to the Steering Connector Rod and slide down over metal Rudder Shaft. Ensure the Rudder is pushed fully up into the Hull then, pushing the Rudder Arm down, tighten the grub screw. This will locate on the flat section of the metal Rudder Shaft.
- 4 Set the Rudder Blade so that it's in perfect fore/aft alignment and tighten the top grub screw to locate the tiller arm onto the Steering Connector Rod.

Note: Rudder alignment will need to be checked and adjusted when the boat is first powered up with the radio gear switched on.

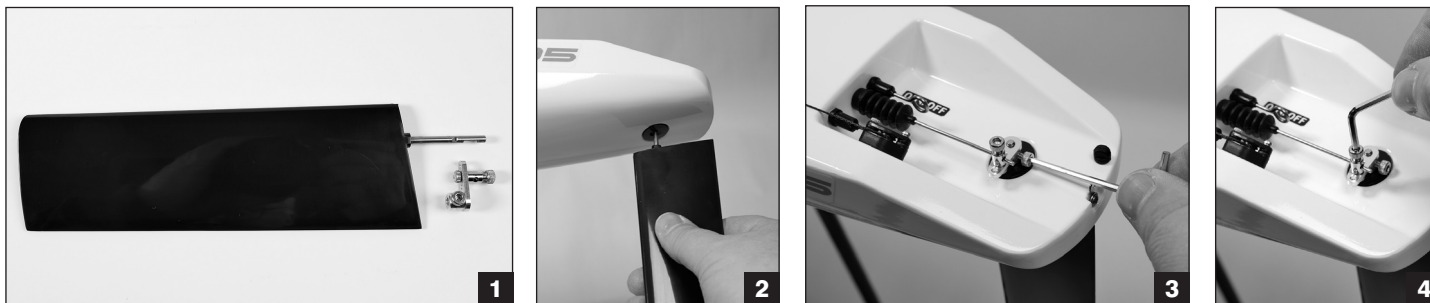

## MAINSAIL RIGGING

Note: Before you start building the rig it's important that you read the three points below, they apply to the whole of the rigging procedure.

- To avoid the Dyneema cord fraying when cut, put a few drops of thin CA glue into the cord at the position of the cut then cut through the glued cord at an angle. You will then have a hard, sharp point to the cut end that will be easy to thread through the Bowsies.
- After tying a knot and trimming off any spare cord, put a drop of thin CA glue on the knot to secure it. Extra time spent securing all knots at this stage will ensure the long term reliability of the boat.
- Thread all Bowsies correctly as shown in the following diagram:-

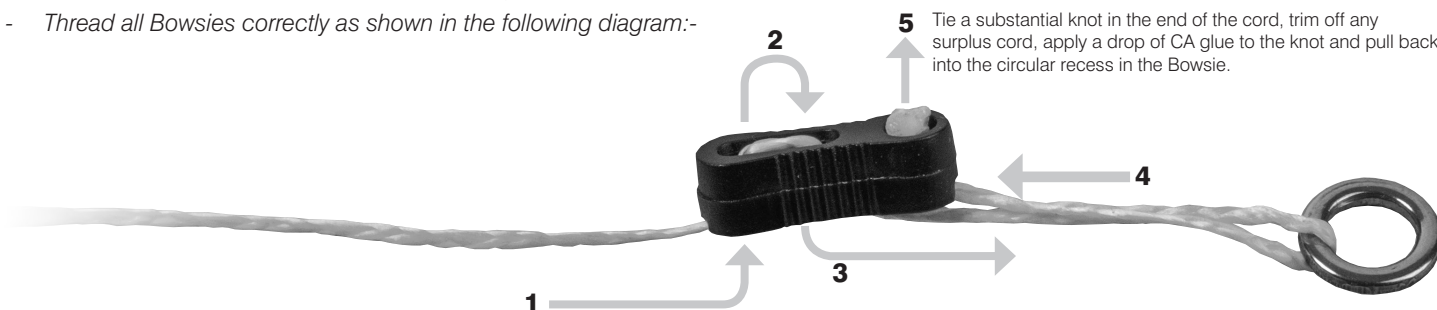

### RIGGING PROCEDURE

If you follow all the dimensions stated in these rigging instructions, the boat will have a good, basic rig trim that will give it the sailing characteristics and performance the designers intended.

- 1 Adjust the Sliding Deck Plate to align with the second graduation from the back as shown below. Tighten the retaining bolt.

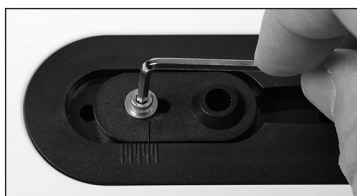

- 2 Set the position of the Mainsheet Guide and Silicon Ring SR4 to the position shown below

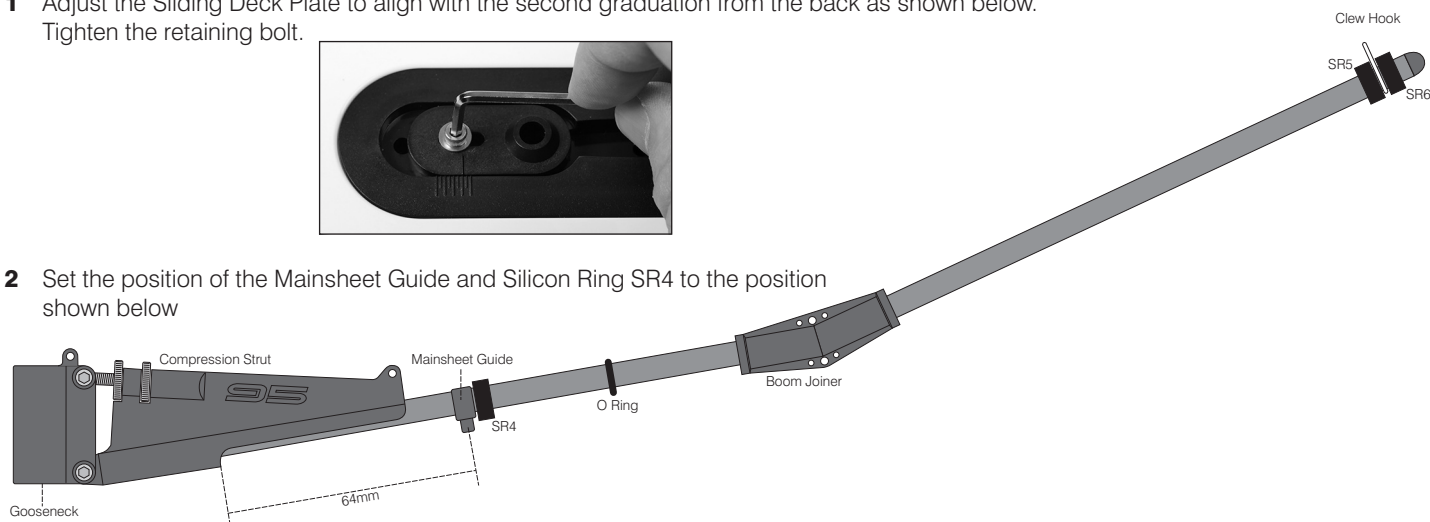



- 3 Fit the wire Mainsail Luff Rings to all six eyelets down the Mainsail Luff (front edge).
- 4 Slide the Mast Stub into the base of the Mast, taking care that the bevelled edge of the plastic collar is facing downwards.
- 5 Slide the whole Main Boom assembly on to the Mast Stub from below.
- 6 Starting with the lower Mainsail Luff Ring, slide all rings down the Mast.
- 7 Push the Backstay Crane and Masthead Plug assembly into the top of the Mast. Cut a 250mm length of Dyneema and tie the head of the Mainsail to the Backstay Crane as shown. Align the top of the sail with the top of the metal mast reinforcement ring. *Note: Tie this with only a single strand of Dyneema, this will allow the head of the sail to swivel easily when the boat is running with the wind and the booms are sheeted out at 80°.*
- 8 Cut a 300mm length of Dyneema and tie the Cunningham (downhaul) as shown. Start by tying one end to the eye in the top of the Gooseneck fitting, take the cord through the eye at the bottom of the Mainsail Luff, back through the Gooseneck eye, lead it back along the Boom, through a Bowsie and the eye in the Compression Strut fitting and finish off back through the Bowsie.
- 9 Hook the eye in the Mainsail Clew (bottom rear corner) onto the Mainsail Clew Hook.
- 10 Using a pair of thin nosed pliers close up slightly the open end of the Hook to prevent the sail eye slipping off the hook when sailing. *Note: This can be opened out again with a flat bladed screwdriver if you need to remove the sail.*
- 11 Cut a 900mm length of Dyneema for the Backstay. Tie one end to the end hole in the Backstay Crane (see photo 7). Tie one of the supplied 6mm metal rings to the bottom end (see photo 12). Slide the Mast and rigged Mainsail into the Mast Socket in the deck.
- 12 To make the adjustable lower section of the Backstay, cut a 500mm length of Dyneema, tie a loop in one end, thread the other end through the first two holes in a Bowsie, then through the metal ring at the bottom of the Backstay and finish off back at the Bowsie. Hook the loop into the metal hook in the Transom (back edge of the hull), apply a light tension to the Backstay, position the Bowsie roughly midway along the lower cord and tie it off
- 13 Adjust the Compression Strut so that the Leech (back edge) of the Mainsail is under light tension and then back it off a turn to allow the Leech to twist slightly. Adjust the Cunningham to apply very light tension down the Luff of the sail.
- 14 Set the length of the Backstay as shown in the diagram opposite.
- 15 Adjust position of Silicon Rings SR5 & SR6 and the Mainsail Clew Hook so the Mainsail Foot can form a curve with a distance of approximately 25mm between the centre of the boom tube and the sail foot at its midpoint.

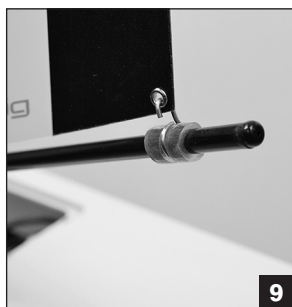
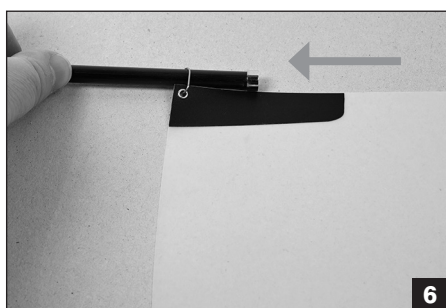
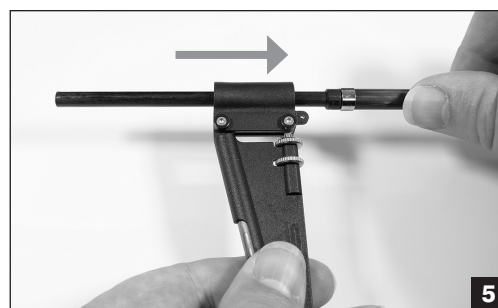
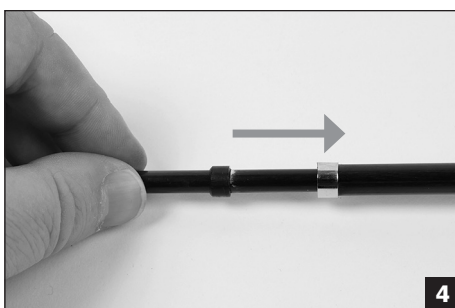
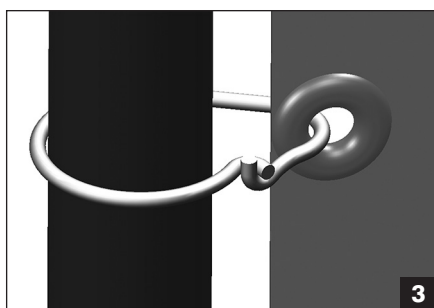

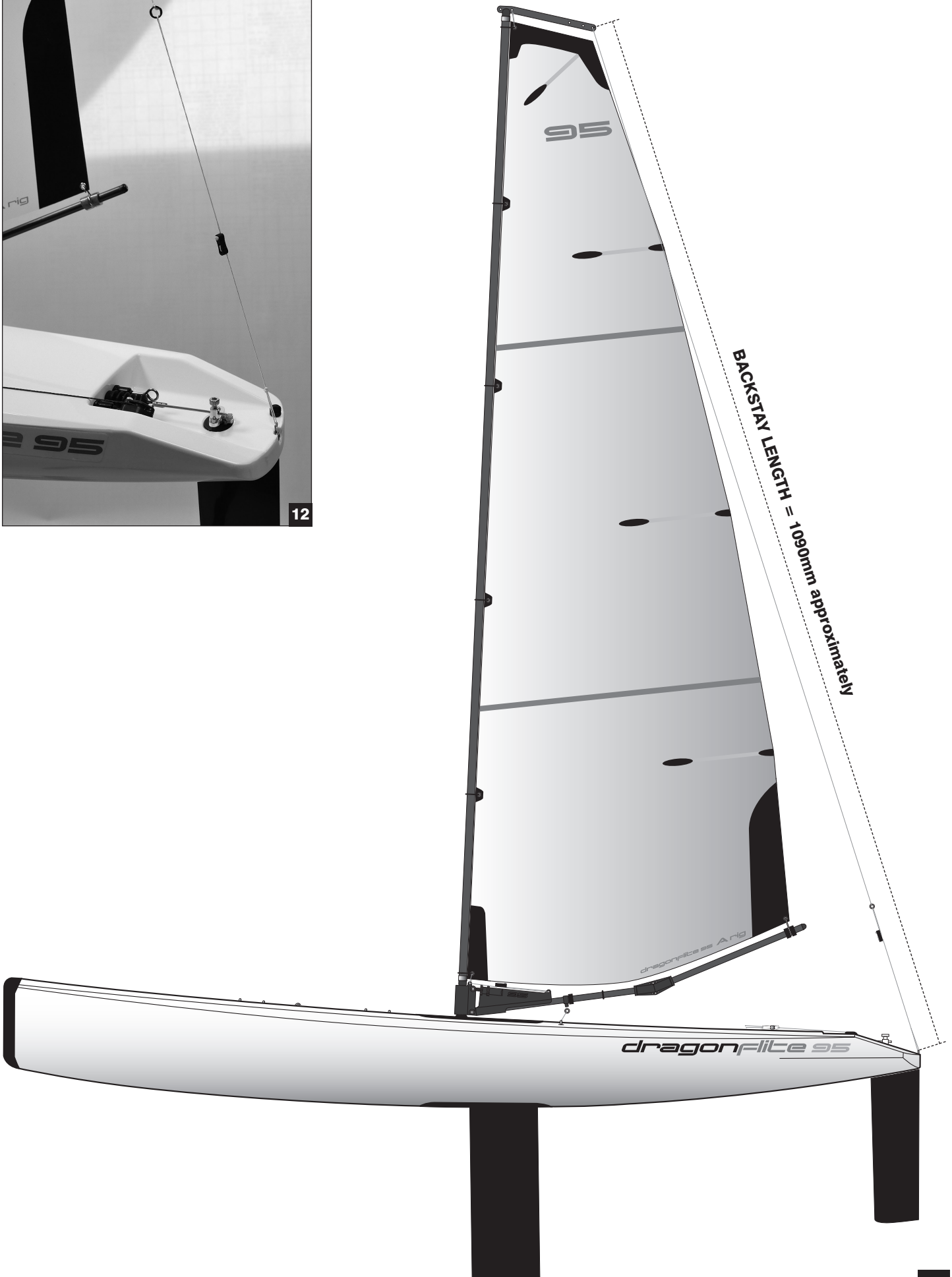
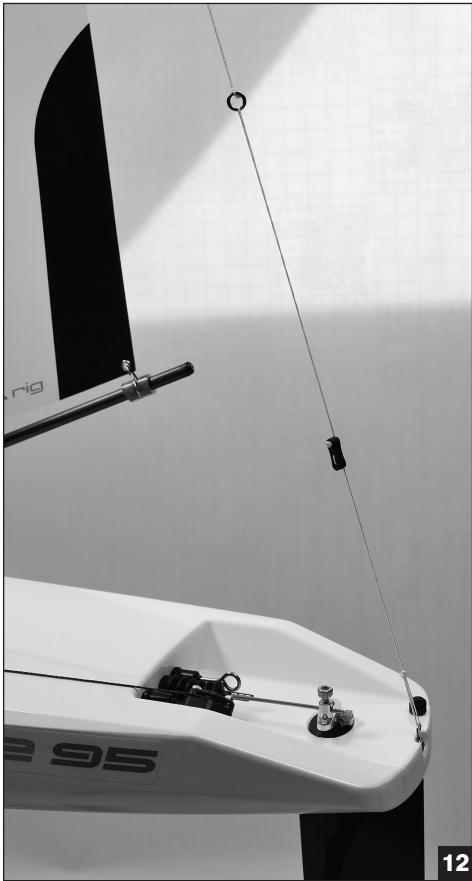

## JIB BOOM SETUP

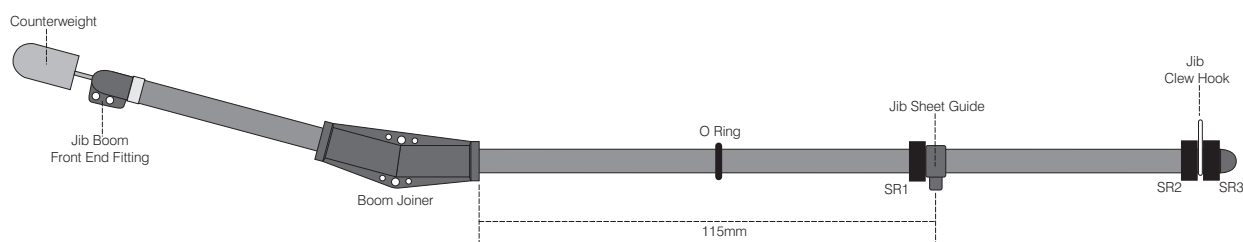

- 1 Set the Jib Sheet Guide and Silicon Ring SR1 to the position shown above.
- 2 Cut a 450mm length of Dyneema to form the Jib Boom hook-down. Tie a loop of approximately 25mm length in one end and secure the knot with a drop of CA glue. Make a mark at 65mm from the end of the loop.
- 3 Thread the Hook-Down line as shown in photo 3. Start by threading the loose end of the cord up through the lower, central eye in the Boom Joiner, then through the top, central eye, back down through the lower eye again, lead it forwards along the underside of the Boom, through the first two holes in a Bowsie, through the rear of the two eyes in the Front End Fitting and take it back through the final hole in the Bowsie. Do not tie off the final knot until completing the following stage. Adjust the cord so that the mark you made is positioned at the lower edge of the Boom Joiner and set the Bowsie midway between the front end fitting and the boom joiner and tie off the final knot to secure the Bowsie.

*Note: When the full rig is completed the easiest way to install the rig is as follows:*

- Insert the Mast into the Mast Socket in the Hull.
- Slacken off the Bowsie adjuster on the Jib Hook-Down, thread the loop through the front Deck Eye (Deck Eye 1), lead it back through Deck Eye 2 and hook the loop over the Jib Deck Hook. Tighten the Hook-Down Bowsie to get the Jib Boom as low to the deck as possible.
- Hook the Backstay on to the Backstay Hook in the Transom and tension the Backstay Bowsie.
- When de-rigging do the reverse of this process. Using this rigging procedure there is no need to adjust the Forestay tension so the correct rig trim is quick and easy to achieve.

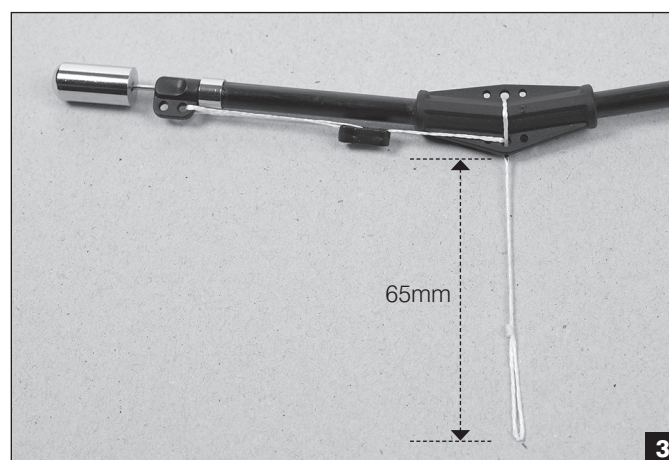
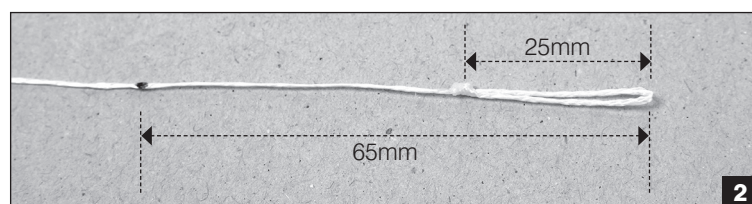

## RIGGING THE JIB

- 4 Cut a 200mm length of Dyneema and tie one end to the front hole in the Backstay Crane. Tie one of the 6mm Metal Rings to the other end at a distance of 15mm from Backstay Crane hole.
- 5 Remove the Counterweight from the front end of the Jib Boom, make sure it is screwed on tightly to its metal shaft and secure the thread with a drop of thin CA glue.

*Note: At this stage make sure the Jib Luff is free to slide on its wire Forestay. If it is sticking at any point gently free it off taking care not to crease the sail.*

- 6 Push the Counterweight shaft through the loop in the bottom of the wire Forestay and back into the Front End Fitting leaving approximately 5mm of shaft showing.
- 7 (Not shown - see photo 9 on page 6) Hook the eye in the Jib Clew (bottom rear corner) onto the Jib Clew Hook.
- 8 (Not shown - see photo 10 on page 6) Using a pair of thin nosed pliers close up slightly the open end of the hook to prevent the eye slipping off the hook when sailing. *Note: This can be opened out again with a flat bladed screwdriver if you need to remove the sail.*
- 9 Cut a 250mm length of Dyneema to form the Jib Cunningham (downhaul at the lower front corner of the sail). Start by tying one end to the lower front hole in the Boom Joiner(a), take it forwards through the first two holes in a Bowsie(b), then forward through the front eye in the Front End Fitting(c), up through the sail eyelet(d) and back down through the eye(c) again and back through the final hole in the Bowsie(e). Set the Bowsie in a central position and adjust the cord to form a gap of 5mm between the bottom edge of the sail and the top edge of the Front End Fitting and tie off the final knot to secure the Bowsie.



- 10 Slacken off the Bowsie adjuster on the Jib Hook-Down, thread the loop through the front Deck Eye (Deck Eye 1), lead it back through Deck Eye 2 and hook the loop over the Jib Deck Hook. Tighten the hook-down Bowsie to get the Jib Boom as low to the deck as possible.
- 11 Cut a 200mm length of Dyneema to form the top of the Forestay. Tie one end to the wire loop in the top of the Forestay wire, thread up through the first two holes of a Bowsie, through the metal ring and back through the final eye of the Bowsie. Pull some tension into the Forestay and tie off the final knot in the Bowsie with the Bowsie positioned about 10mm from the metal ring. When secured, pull down to apply more tension into the Forestay until the Luff of the Jib starts to wrinkle. Cut a 150mm length of Dyneema and tie the top eyelet in the jib to the wire loop in the Forestay with enough tension to remove the wrinkles in the sail's Luff.

*Note: Before tying the sail head ensure the gap is still 5mm between the Jib Foot and the top of the Front End Fitting. After this is complete, the Bowsie on the Jib Cunningham can then be used to fine tune the tension in the Jib Luff.*

- 12 Now set the mast rake (angle) by adjusting the Forestay Bowsie to obtain the dimensions shown in the rig diagram on the next page. To achieve these measurements you will have put a lot of tension into the Forestay and Backstay. This tension is needed to keep the rig stable which will give you consistent handling characteristics in different wind conditions.
- 13 Cut a 1000mm length of Dyneema to form the Topping Lift. Start by tying one end to the metal ring in the Forestay (See photo 11). Then tie the bottom end of the cord to the ring attached to the Bowsie adjuster at the back end of the Jib Boom. Adjust the Bowsie to allow a little slack in the Jib Leech (back edge).
- 14 Adjust position of Silicon Rings SR2/3 and the Jib Clew Hook so the Jib Foot can form a curve with a distance of approximately 25mm between the centre of the boom tube and the sail foot at its midpoint.

At this stage you have completed the rigging, the next sections will cover the fitting of 'Sheets' (control lines) to the Booms and setting the rig up for best performance and boat trim.

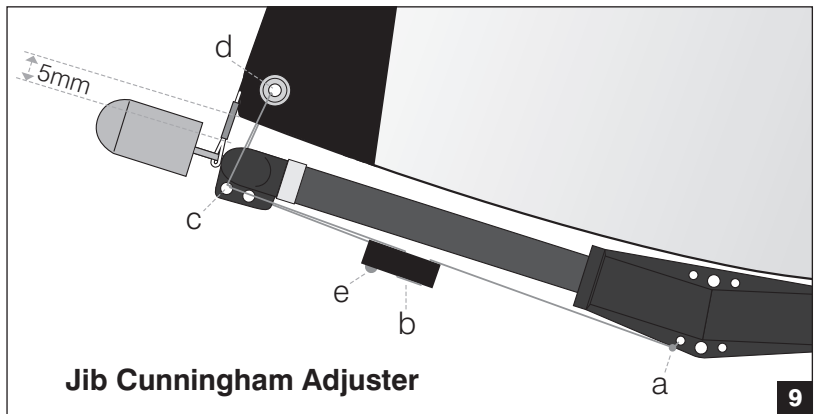
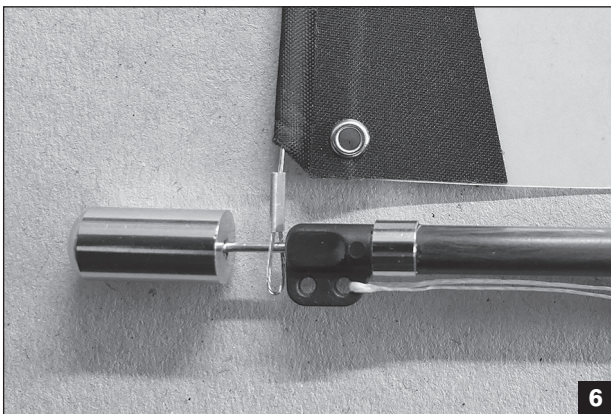
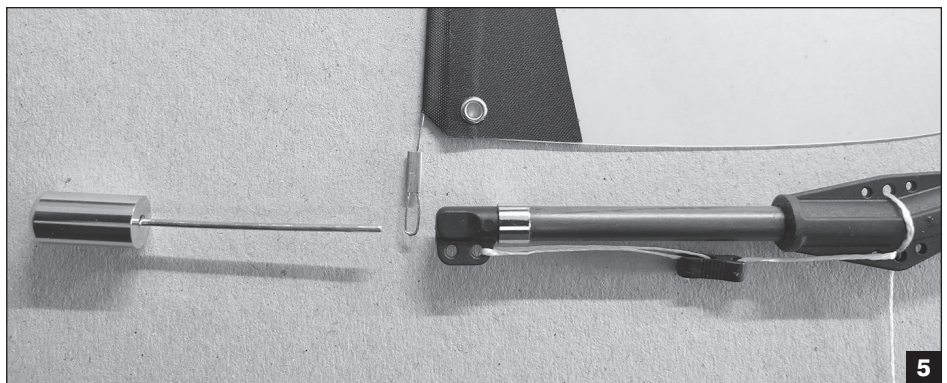



## POWERING UP THE BOAT

If you've bought the 'Ready To Race' version of the boat you will have the Joysway Transmitter and Receiver. The transmitter (Tx) and Receiver (Rx) will already be 'bound' and full operating instructions for this radio set are supplied.

If you are using your own Tx/Rx equipment we will assume you will be familiar with all it's functions and the following guide covers the setup of the boat only.

- 1 Connect up the Servo, Winch and Battery Switch cables up to the Receiver as follows:
  - Rudder Servo plugs into Channel 1 socket.
  - Sail Winch plugs into Channel 3 socket
  - On/Off Switch plugs into Battery socket (check your own Tx manual for this connection)
- 2 Install four, AA batteries into the Battery Holder and secure into the tray with the silicone band provided. Plug the batteries into the spare lead from the On/Off Switch.
- 3 With both Tx control sticks in their central positions switch on the boats On/Off Switch by pushing the wire switch arm forwards in the cockpit as indicated by the sticker.

*Note: At this stage check that the control sticks on your Transmitter operate in the correct direction. Looking forward from the back of the boat when the rudder control stick is moved to the right, the Rudder should turn to the right. When the Sail Winch control stick is moved down, the clip on the Winch Line should move to its furthest back position (sheeted in). If either of these actions is reversed, consult your manual for instructions on how to reverse the stick actions.*

- 4 With the rudder control stick and fine adjuster on the Transmitter set in their central position, check to see if the Rudder Blade is centred in line with the Keel when viewed directly from behind. If not, use the Allen Key to adjust the top grub screw on the Rudder Arm.
- 5 Now set the sheeted in and out positions for the Winch Line. Diagram 5 shows the ideal positions for these sheeting points. Set the sheeted in (close hauled) position first. Pull the sailwinch control stick on the Tx fully down with it's fine adjuster set in its central position, if the end of the winch line clip is in a different position to that shown, unscrew the drum on top of the Sail Winch and rotate until the clip position is correct and then re-tighten the drum. The ideal amount of winch line travel between fully sheeted in and out is 128mm. This travel will give you the ideal sheeted out position for running with the wind with the booms out.

*Note: It's a good idea to mark these two positions on the deck as a permanent reference points for consistent sheeting adjustment. The sheeting points shown are not too critical but what is important is the amount of travel between the two points of 128mm. On better quality Transmitters you will be able to adjust the sheeting end points individually through its software menus.*

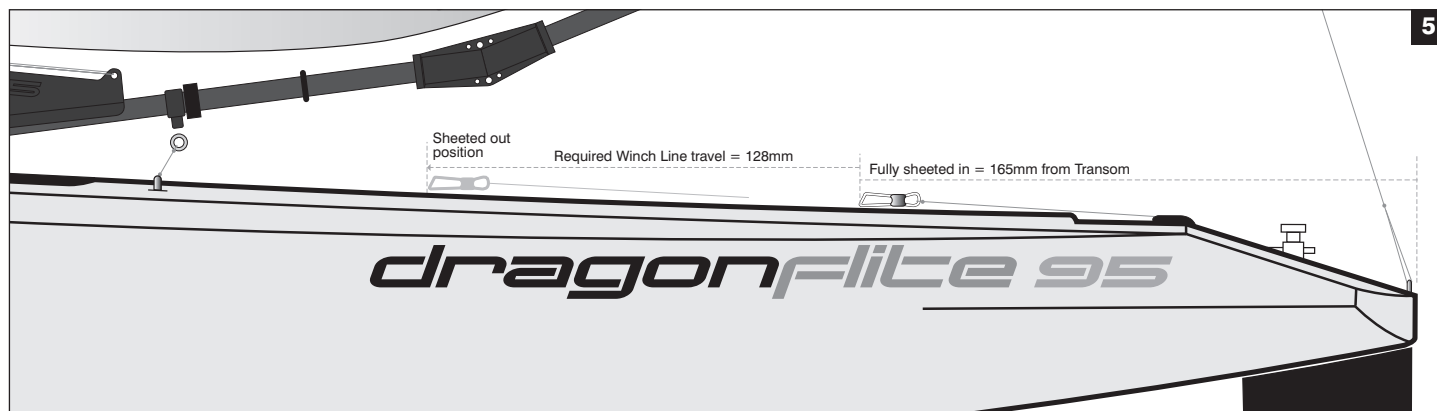
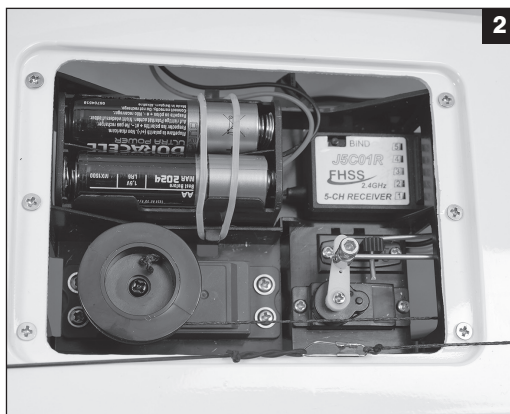



## SHEETING SETUP

- Adjust the bowsies on the mainsheet bridle to position the metal sheeting ring centrally in the position shown in photo 1. It is essential for consistent sheeting angle on both port and starboard tacks (When looking forward from the back of the boat if the wind is coming over the right hand side if the hull you are sailing on starboard tack).
  - Cut a 180mm length of Dyneema cord, tie one end to the Mainsheet Ring, thread it through a Bowsie, then through the smaller hole in the plastic Keel Bolt Plate (photo 2) supplied in the fittings pack, and back to the bowsie. Anchor the Keel Bolt Plate down by passing the top Keel Bolt through it and re-tightening the Keel. Adjust to length as shown in the photo 3, and tie-off the loose end at the Bowsie. This line is to locate the Mainsheet Ring directly underneath the Mainsheet Guide on the Boom.
- For initial sheet setup of both the Jib and Mainsheet, pull the winchline in to its close-hauled (sheeted fully in) position and don't move it until both sheets are fully installed.**
- Cut a 600mm length of Dyneema for the Mainsheet. Tie a loop in one end and clip it in to the Winch Line Clip(a), run it forward and through the metal ring on the Mainsheet Bridle(b), up through the Mainsheet Guide(c) on the Mainboom, back along the boom through the 'O' Ring(d), through the first two holes in a Bowsie(e), back through the first hole in the Boom Joiner(f) and forward through the final hole in the Bowsie(g). With the Mainboom positioned on the hull's centreline, position the bowsie approximately midway between (c) & (f) and tie off the final knot to secure the Bowsie.
  - Cut an 850mm length of Dyneema to form the Jibsheet. Tie a loop in one end and clip it in to the Winch Line Clip(a), run it forward underneath the Mainsheet Bridle(b), forward through Deck Eye 3(c), up through Jibsheet Guide(d), run it forwards underneath the Jib Boom, through the 'O' Ring(e), through the first two holes of a Bowsie(f), forward and through the rear hole in the Boom Joiner(g) and back through the final hole in the Bowsie(h). Hold the back end of the Jib Boom over the edge of the Hull (Gunwhale), position the Bowsie approximately midway between (d) & (g) and tie the final knot to secure the Bowsie.
  - With the Winchline still in its fully sheeted in position adjust the Bowsies on the Jibsheet and Mainsheet so the boom rear ends are in the positions shown in Diagram 6 (opposite page). If you have the 128mm of winchline travel set up when you sheet out the booms should be approximately in positions shown.

You should now almost have a fully setup rig. The only trimming left to do is to adjust the amount of twist in the leeches (back edges) of both sails. The twist in the Mainsail can be controlled by adjusting the Compression Strut, the Jib twist is controlled by adjusting the Bowsie at the bottom of the Topping Lift. It's hard to define the amount of twist in figures, but the photos on the opposite page show a well adjusted rig with correct twist and boom sheeting angles. If you can match this rig setting you will have a well balanced and easy to sail boat.

- Before you put the boat on the water fit the clear Deck Hatch and seal with one of the supplied adhesive Deck Patches. An easy method to do this is to lay the adhesive Deck Patches face down on a smooth, hard surface, peel back the backing paper and place in the clear Deck Hatch upside down in the centre of the patch. Turn over and locate in the Deck Hatch Opening in the deck, make sure the adhesive patch is pressed down with no crease to form a waterproof seal around the hatch.

**You are now ready to sail!**

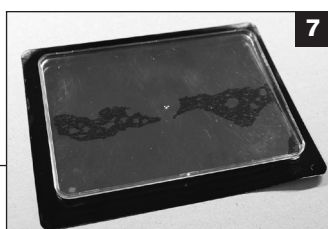
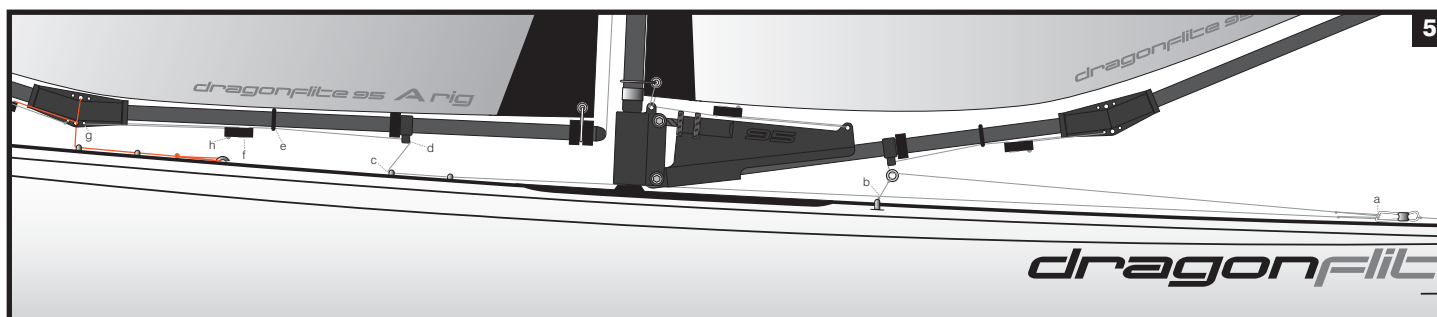
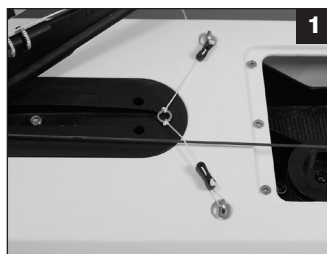



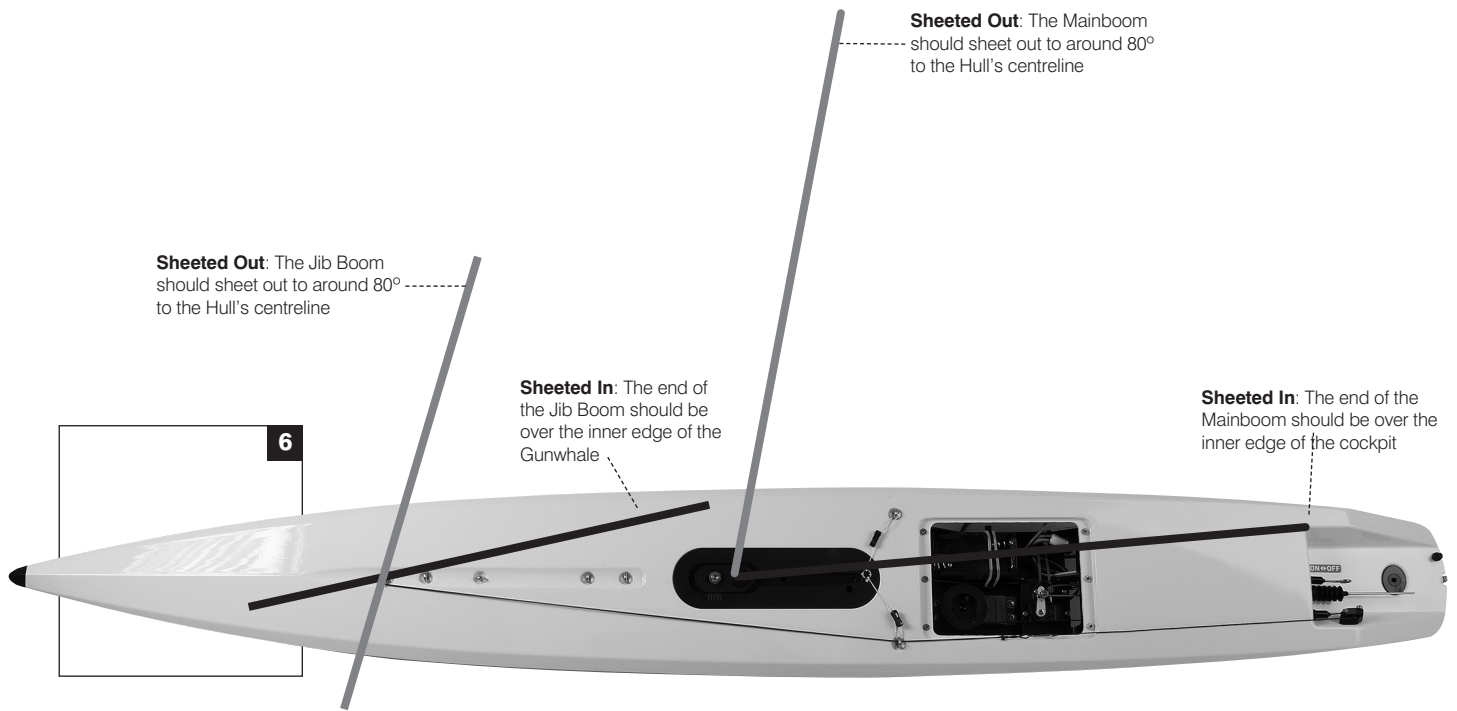

# BASIC SAILING TERMINOLOGY

Unlike propeller driven boats that you basically point and accelerate, sailboats present an interesting challenge. Sailing requires constant reaction to water movements, any wind gusts and any wind direction changes. These reactions then require adjustment of the rudder and sails in order to find the best possible course. There is no substitute for actual 'on-the-water' experience and after your first couple of outings you may want to read through this manual again in order to help you to gain a better understanding of the 'art' of sailing. While learning to sail, it is a good idea to pick up on as much sailing terminology as possible. This will make it easier to grasp some aspects of the sport.

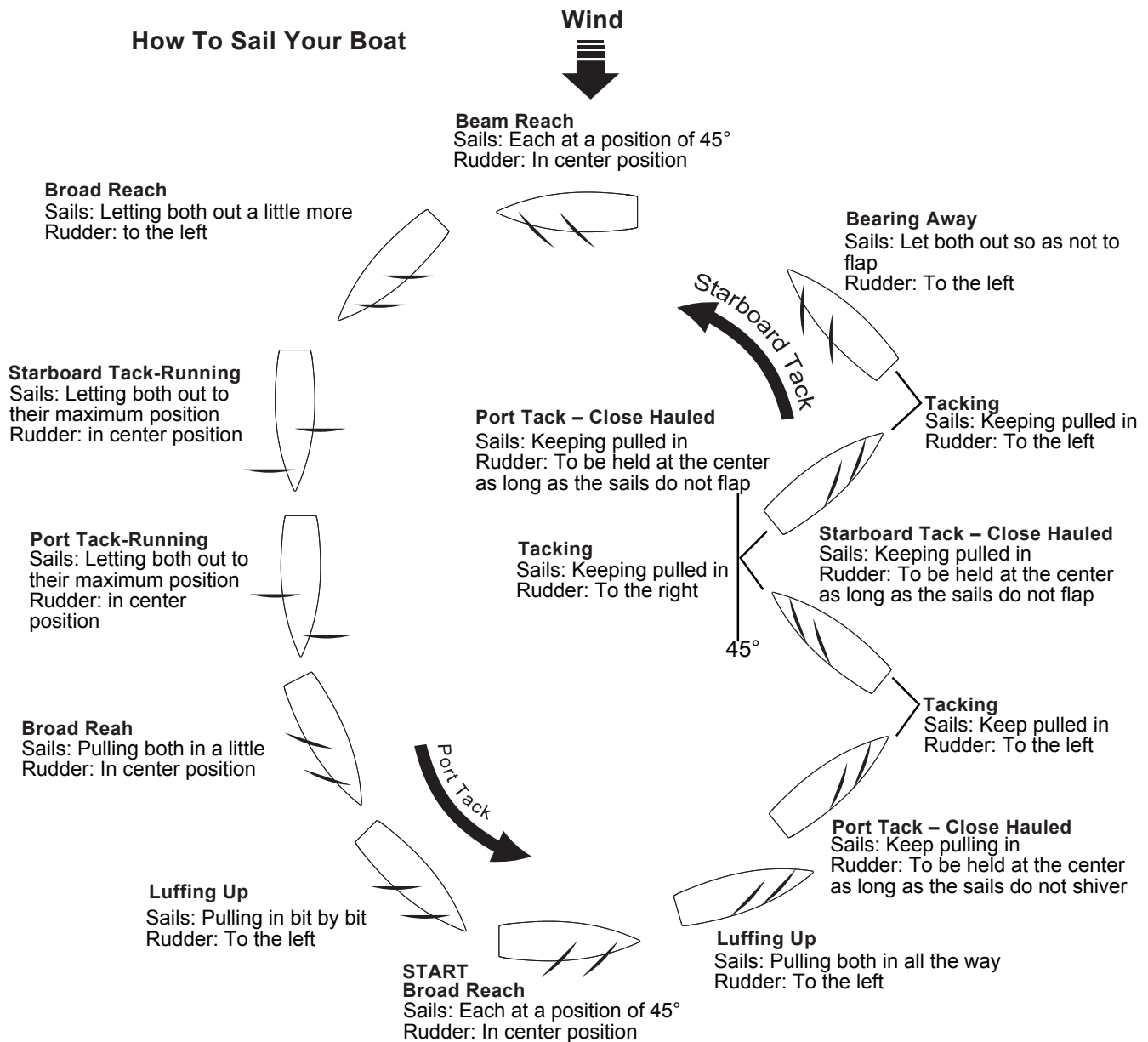

## IMPORTANT NOTICE

- Only sail your DragonFlite 95 in still bodies of water. Never sail it in running water such as rivers or tidal waters. If you loose control of the boat you could loose it forever!
- Never attempt to swim after a stalled or stuck boat. Wait patiently for the boat to drift ashore or be rescued.

## MAINTENANCE

If properly rigged and maintained the DragonFlite 95 will be a very 'dry' boat. This is a very good thing as water and electrics are not the best of friends!

There are some essential steps you need to take to keep your boat working as it should, these are:

- The bearings in the top and bottom of the Gooseneck should be washed in clean, fresh water after every outing if you sail in saltwater.
- Regularly lubricate the bearings with bearing lube or any similar product.
- Wash the whole boat and rig with clean, fresh water after every outing if you sail in saltwater.
- Open the Hatch Cover and allow the inside of the boat to completely dry out after sailing. Do not store the boat with either water or condensation inside the hull, it will lead to electrical failure through corrosion or 'black wire' failure.
- Dyneema cord can shrink in certain conditions. So check often that all your rig settings remain correct.
- Handle and store the Sails with great care. Don't leave them flapping whilst your boat sits on its stand, lay the boat down on a soft surface with the rig downwind of the hull. When not in use keep the rigs in a rigid rig box or fairly stiff rig bag. Look after your rigs - they are your boat's engine!

## SPARE PARTS LIST

Item No	Item Name
881181	<b>DF95 Complete "A" Rig Assembly (No Sails)</b>
881182	<b>DF95 Complete "B" Rig Assembly (No Sails)</b>
881183	<b>DF95 Complete "C" Rig Assembly (No Sails)</b>
881184	<b>DF95 Complete "D" Rig Assembly (No Sails)</b>
881105	<b>DF95 "A" 50 micron mylar film sails</b>
881106	<b>DF95 "B" 75 micron mylar film sails</b>
881107	<b>DF95 "C" 75 micron mylar film sails</b>
881108	<b>DF95 "D" 75 micron mylar film sails</b>
881109	<b>DF95 Mast Pack A</b>
881110	<b>DF95 Mast Pack B</b>
881111	<b>DF95 Mast Pack C</b>
881112	<b>DF95 Mast Pack D</b>
881113	<b>DF95 Mast Head Pack A</b>
881114	<b>DF95 Mast Head Pack B</b>
881115	<b>DF95 Mast Head Pack (C &amp; D identical)</b>
881185	<b>DF95 Main Boom Pack A</b>
881186	<b>DF95 Main boom Pack B</b>
881187	<b>DF95 Main Boom Pack C</b>
881188	<b>DF95 Main Boom Pack D</b>
881119	<b>DF95 Jib Boom Pack (A &amp; B identical)</b>
881121	<b>DF95 Jib Boom Pack C</b>
881120	<b>DF95 Jib Boom Pack D</b>
881122	<b>DF95 Mainsail luff Ring (PK10)</b>
881123	<b>DF95 Transparent Hatch(PK2)</b>
881124	<b>DF95 Water seal tape(PK2)</b>
881125	<b>DF95 Deck cloth patch(PK4)</b>
881126	<b>DF95 Front bumper(PK2)</b>
881127	<b>DF95 Sheeting pulley block(PK2)</b>
881128	<b>DF95 Fin box and mast fitting</b>
881129	<b>DF95 Rudder</b>
881130	<b>DF95 Carbon keel with bolts</b>
881131	<b>DF95 Bolts(PK4)for keel</b>
881132	<b>DF95 Ballast with plastic Shoe fitting</b>
881133	<b>DF95 Plastic shoe</b>
881134	<b>DF95 Pushrod</b>
881135	<b>DF95 Switch connector+Switch rod</b>
881136	<b>DF95 Painted Hull(without decals)+front bumper</b>
881137	<b>DF95 Jib Boom Front End Fitting(PK4)</b>
881138	<b>DF95 Boom Joiner (PK4)</b>
881140	<b>DF95 Hull decals set</b>
881203	<b>Metal sail crew ring(PK10)</b>
881204	<b>0.6mm Dyneema cord(10m length)</b>
881209	<b>Jib boom counterweight with shaft(PK4)</b>
881210	<b>Bowsie(PK10)</b>
881211	<b>10cm Silicon tube+"O"ring(PK4)</b>
881212	<b>Sheeting elastic(2m)</b>
881217	<b>Aluminum alloy rudder arm set</b>
881218	<b>Plastic servo tray with screws</b>
881225	<b>Jib hook(PK10)</b>
881226	<b>Sail winch servo</b>
881227	<b>Waterproof Bellows(PK4)</b>
881228	<b>Cord attachment clip (PK10)</b>
881229	<b>Mainsheet metal ring (PK4)</b>
610313	<b>J5C01R Receiver</b>
610314	<b>J4C03 transmitter(MODE2)</b>
610315	<b>J4C03 transmitter(MODE2)with J5C01R Receiver</b>
880514	<b>9g metal gear rudder servo</b>
880532	<b>Deck eyes (pk10)</b>
880536	<b>Rubber bung (PK4)</b>
880552	<b>Battery box for receiver</b>
880623	<b>Winch line rubber cap(PK5)</b>
990202	<b>Plastic boat stand</b>
881154	<b>Mainsheet Bridle Keelbolt Fitting (PK 2)</b>



#### FCC REQUIREMENT



This device complies with Part 15 of the FCC Rules. Operation is subject to the following two conditions: (1) This device may not cause harmful interference, and (2) This device must accept any interference received, including interference that may cause undesired operation.

CAUTION: Changes or modifications to this product not expressly approved by the party responsible for compliance may void the user's authority to operate the equipment.

For more information about the boat and the DragonFlite 95 Racing Class please visit

**[www.dfracing.world](http://www.dfracing.world)**